

STANLEY®



Door Closers

PRICE LIST 67DC

EFFECTIVE: JANUARY 1, 2018

dormakaba 

STANLEY®

Contents

Terms and Conditions of Sale	4-5
Warranty	6
General Product Information	7
How To Order	7
D-4990/D-4990T Low Energy Operator	8
D-4550/D-4551 Series Closers	9
D-4550EH Electronic Hold Open	9
D-3550/D-3551 Series Closers	10
D-1610/D-1611 Series Closers	11
CO30/CO50 Series Concealed Closers	12
Mounting Accessories	13-14
Quoting & Ordering	15-16
Returned Authorization (RA)	17
Returned Authorization (RA) Non-Warranty	18
Fullfillment Issues	18
Order Form	19
Return Order Request	20

STANLEY®

TERMS AND CONDITIONS OF SALE

The terms and conditions contained herein shall govern the sale of all Stanley products located in the Stanley price catalog and/or offered for sale by Stanley Security Solutions, Inc., except for those products as set forth under separate Stanley Value Added Reseller Agreements. The acceptance of any order is expressly made conditional upon your assent to these Terms and Conditions of Sale.

PRICES: Stanley reserves the right, in its sole discretion, to change or amend its price list (including, but not limited to, adding or removing Products from the price list), and standard terms and conditions of sale as contained in its catalogs, price list or published sales policies, without incurring any liability whatsoever to its Customer or others. All orders will be filled at the Stanley List Price in effect at the time of order placement. All prices are subject to change without notice and are not guaranteed.

TAXES: List prices do not include federal, state or local taxes.

ORDERS: No order for Products shall be deemed to have been accepted by Stanley until written notice of its acceptance is received by the Customer from Stanley via an order acknowledgement. Stanley reserves the right, in its sole discretion, to decline to accept any order. Purchase Orders will bind Stanley only to the extent accepted by Stanley's written confirmation or delivery.

Stanley will attempt to fill orders in the order in which they are received, subject to prior orders. However, Stanley reserves the right to allocate orders or fill an order or orders ahead of prior orders, if, in its judgment, the facts warrant such a change.

Any additional provisions in a Purchase Order, including any pre-printed terms, shall be void and not binding on Stanley, unless expressly accepted by Stanley. For greater certainty, the acceptance by Stanley of a Purchase Order shall not be deemed acceptance of the additional terms of such Purchase Order.

Stanley will accept orders via phone, email, fax or courier. Stanley will send out an order acknowledgement for all orders received via email, phone or fax.

Note: Receipt or possession of this price catalog does not grant approval to quote or purchase Stanley products. Please contact your Stanley Sales Representative for further details.

KEYING SYSTEM ORDERS: All orders of keying systems specifying delayed fulfillment must be fulfilled within twelve (12) months of the order date. Said request for fulfillment must include complete keying instructions for the order to be acknowledged with an estimated delivery date. Failure to properly request fulfillment of the order within twelve (12) months of the order date will make the order void and nonrefundable.

SPECIAL ORDERS: Any modification to a standard product configuration is considered a special order. No credits will be issued for returned special orders unless authorized by Stanley Customer Service.

INCOMPLETE ORDERS: An incomplete order is one that is not fully specified according to the appropriate nomenclature required for that product. Any incomplete order will not be entered and will be referred to the appropriate Stanley Sales Representative for resolution.

SAMPLES: Please contact your local Stanley Sales Representative for sample requests.

MINIMUM CHARGE: The expense of handling an order necessitates a minimum charge of \$50.00 net per invoice.

CREDIT LIMITS: Stanley's policy is to extend Net 30-day terms/open account combined with a credit line based on financial capacity. For all accounts Stanley requires a Credit Application and Sales Tax Exempt Certificate (if applicable). Stanley evaluates traditional sources of credit information: D&B, trade and bank references, financial information, and business plans. The supply of credit herein shall be at the discretion of Stanley. If available information and/or financial circumstances will not support open accounts terms, Stanley offers Cash in Advance and Credit Card (MasterCard or VISA) terms. Stanley performs periodic reviews of credit lines and terms of payment and may request updated financial information.

Stanley reserves the right to withhold delivery of Product if Customer does not meet Stanley's credit requirements for the amount of Product ordered, or the amount of Product which remains unpaid (whether or not overdue) exceeds the limit established by Stanley for Customer. Customer shall provide, at Stanley's request, an acceptable letter of credit or guarantee or security in a form and amount determined by Stanley.

If Customer shall become overdue on its account or otherwise defaults in any payment to Stanley or if its financial condition shall at any time appear inadequate to warranty further shipment on an open account basis, Stanley shall have the right, without liability, to refuse to accept any or all orders, to cancel any and all orders, to delay shipments, or to require advance payment before accepting or shipping any orders. All orders and all shipments are subject to approval by the Stanley Credit Department.

PAYMENT TERMS: Stanley standard payment terms are 2% 15, net 30 days from date of invoice.

Effective September 28, 2014, a \$45.00 convenience fee will apply to all payments made by Credit Card towards open invoices on your account. You may choose to pay by credit card by reaching out to your Credit Analyst directly in order to process payment. You can avoid paying the \$45.00 convenience fee by enrolling and paying open invoices via Billtrust Invoice Gateway (<https://secure.billtrust.com/stanleymechnical/ig/signin>) with an ACH Payment (bank transfer from checking or savings account) free of charge. Payments by check, or money order should continue to be sent directly to the remit-to address noted on invoices.

Stanley shall be entitled to charge and Customer shall pay interest on overdue invoices at the rate of two percent (2%) per month calculated from the date of the invoice to the date of payment, including any attorney fees incurred by Stanley resulting from the collection of such overdue payment. Customer shall pay all sums owing to Stanley without any deduction or abatement and Customer shall have no right of set-off.

In the event that Customer disputes any portion of the payment due, Customer shall be obligated to pay the balance which is not the subject of dispute.

Without limiting any other rights it may have under these terms of sale and applicable law, all of Stanley's obligations under this Agreement, including obligations of supply, or any Purchase Order, can be suspended or cancelled should Customer be delinquent in making payment for previously shipped Products.

October 2015

TERMS AND CONDITIONS OF SALE (continued)

INTERNATIONAL SALES:

International Resellers located outside of the United States of America who place orders are subject to and must pay by (1) Cash in Advance, (2) Confirmed Irrevocable Letter of Credit, (3) Standby Letter of Credit.

All international shipments shall be FCA (Incoterms 2010) from Stanley's facility in Indianapolis, Indiana USA. Stanley shall be deemed to have delivered all Products and related goods when such are put in the custody of a carrier at Stanley's plant or warehouse above, at which time all title and risk of loss or damage shall pass to Customer.

SHIPPING/FREIGHT: All Products shall be shipped FOB Origin domestic or FCA International (INCOTERMS 2010) from Stanley's facility in Indianapolis, Indiana USA. Stanley shall be deemed to have delivered all Products and related goods when such are put in the custody of a carrier at Stanley's plant or warehouse above, at which time all title, risk of loss or damage shall pass to Customer. All shipments will be made in accordance with the preferred routing, carrier assignments, and operational guidelines of Stanley. Customer shall bear all costs of freight, insurance and associated costs and shall make all arrangements for same.

Single or combined shipments including Stanley lock sets, exit devices, hinges and door closers will be considered for free freight with orders at or above \$5000 net (product combination must be on same purchase order). Orders less than \$5,000 will be shipped freight prepaid with shipping cost added to the invoice, including a nominal freight charge to be determined by Stanley at time of shipping.

Hinge only orders will be considered for free freight with orders at or above \$750 net. Orders less than \$750 will be shipped freight prepaid with shipping cost added to the invoice, including a nominal freight charge to be determined by Stanley at time of shipping.

These freight terms apply only to a single destination within the contiguous United States.

Should a shipment qualify for one of Stanley's free freight programs, the Products shall be shipped FOB Origin domestic (with exception to prepaid freight) or FCA International (INCOTERMS 2010) (with exception to prepaid freight) from Stanley's facility in Indianapolis, Indiana USA.

DELIVERY: Orders shall be acknowledged and given a scheduled delivery date based on estimated manufacturing lead times. Manufacturing lead time will begin once all information is received to process an order. Delivery dates given by Stanley as part of order acknowledgment for accepted orders for Products or related goods will be honored by Stanley on a best effort basis. Shipping dates shown on order acknowledgments are based upon Stanley's estimate and cannot be guaranteed. Stanley will not be liable for any loss or damage resulting from delay in filling orders, including any direct or consequential loss or damage. Stanley reserves the right to make partial shipments unless the order specifies otherwise.

CHANGES/CANCELLATIONS: After orders are entered for manufacturing, changes or cancellations cannot be accepted without Stanley written permission, and may be subject to a change or cancellation charge equivalent to 30% of the purchase price.

Orders for special and/or custom designed goods not immediately saleable to another customer are not changeable, cancelable, or returnable.

RETURNED GOODS: Stanley Customer Service MUST authorize all warranty and non-warranty related returns. Requests for returns can be initiated by submitting an email to BAS-rgacreditgrp.us@dormakaba.com. Only goods with an invoice date of less than one (1) year will be considered for a non-warranty related return and product must be returned in original packaging and in a resalable condition. All material returned to Stanley, regardless of the reason, must have a correct RA number applied to the outside of the shipping carton. A restocking charge of 30% of the purchase price will be applied to the Customer's account except for warranty returns. Transportation charges of returned goods must be prepaid by Customer. All goods must be returned within sixty (60) calendar days of RA issue date. Product not returned in salable condition or after sixty (60) days of the RA issue date is subject to disposal by Stanley with no credit issued.

Stanley cannot authorize the return of discontinued product. Under no circumstances will special order items be accepted for return, unless covered by warranty.

EXPORT REGULATIONS: Customer agrees to conform to, and abide by, the export laws and regulations of the US, including, but not limited to, the Export Administration Act of 1979 as amended and its implementing regulations. Diversion contrary to US laws and regulations is prohibited.

MASTERKEYING: Stanley Masterkey Code and Masterkey Service Policy can be found at www.bestaccess.com.

LIMITED WARRANTY: The terms and conditions outlined above are subject to Stanley's Limited Warranty, which is included in the Stanley Price Catalog and is incorporated herein by reference. Upon return of a defective product, Stanley shall either repair or replace the product, in its sole discretion, in accordance with our standard warranty.

EXCEPT AS SET FORTH HEREIN, STANLEY MAKES NO WARRANTIES, EXPRESSED OR IMPLIED, AND BUYER ACKNOWLEDGES THAT NO REPRESENTATIONS, WARRANTIES, PROMISES OR STATEMENTS HAVE BEEN MADE BY STANLEY, WITH RESPECT TO THIS PRODUCT, OR ANY PART OR PORTION THEREOF. IN ADDITION, STANLEY MAKES NO WARRANTY OF MERCHANTABILITY OF THIS PRODUCT OR ANY PART OR PORTION THEREOF, FOR ANY PURPOSE, NOR ANY WARRANTY WHICH EXTENDS BEYOND THE DESCRIPTION ON THE FACE HEREOF. STANLEY SHALL NOT, IN ANY EVENT, BE LIABLE FOR ANY CONSEQUENTIAL OR INCIDENTAL DAMAGES SUFFERED BY BUYER OR ANYONE CLAIMING BY, THROUGH OR UNDER BUYER, AS A RESULT OF THE CONDITION OF THIS PRODUCT, OR ANY PART OR PORTION THEREOF, AND THERE ARE NO ORAL OR WRITTEN UNDERTAKINGS OR AGREEMENTS OF ANY TYPE PROVIDED BY STANLEY EXCEPT AS EXPRESSLY SET FORTH HEREIN. SOME STATES DO NOT ALLOW LIMITATIONS ON HOW LONG AN IMPLIED WARRANTY LASTS OR PROHIBIT THE EXCLUSION OR LIMITATION OF INCIDENTAL OR CONSEQUENTIAL DAMAGES, SO THE ABOVE LIMITATION AND EXCLUSIONS MAY NOT APPLY IN YOUR STATE.

GOVERNING LAW: These Terms and Conditions of Sale and any subsequent sales agreements between Stanley and Customer shall be construed in accordance with the laws of the State of Indiana. The United Nations Convention on Contracts for the International Sale of Goods shall not apply to this Agreement.

October 2015

WARRANTY

What is Covered: Stanley Security Solutions, Inc. ("Stanley") warrants that **Door Closer models D4550, D4990, D3550 and D1610** manufactured by Stanley and sold under its trade name "**STANLEY**" are free of defects in materials and workmanship as outlined below. The sole and exclusive liability of Stanley under this warranty is limited to the repair or replacement of any Product or component part covered by the warranty at the sole discretion of Stanley.

Who is Covered: This warranty is extended only to Stanley's distributors of products and the end user who purchases products for purposes other than resale (collectively, "Purchaser").

Hardware Warranty Period:

- **Stanley Door Closer mechanical products** shall be warranted for thirty (30) years from date of sale.
- **Stanley Door Closer electrical products** shall be warranted for one (1) year from date of sale.
- **Finishes** shall be warranted for three (3) years from date of sale excluding 10B/613 "Oil Rubbed Bronze" finish.

Stanley Wi-Q™ Technology and B.A.S.I.S. Software:

- Stanley warrants that all software shall be free from defects in materials and workmanship and will function in substantial accordance to the specifications for a period of one (1) year from the date of installation.
- Specific Limitations:
 - This warranty does not cover any post-sales technical support under the following circumstances:
 - Problems caused by misuse of software or hardware
 - Failure to provide a network connection or site phone line for a modem connection, if deemed necessary by Stanley
 - Technical support for network software products
 - Technical support for software installed on computer hardware or computer operating system that is no longer commercially available for purchase.

Warranty Claims: Any Products believed to be defective as covered by this warranty may not be returned without prior written Returned Materials Authorization (RMA) from Stanley Product Support (800) 392-5209 covering specific items and quantities within thirty (30) days from the discovery of the alleged defect(s). Stanley will inform the purchaser where to ship said Product(s), shipping charges prepaid by you, for examination. In the event such examination reveals a defect covered by this warranty; Stanley will, at its sole option, repair or replace the Product, and return it or its replacement to the purchaser, with charges only for shipping.

Exclusions: This warranty specifically excludes, and Stanley shall not be held responsible for the following:

- a) **COSTS ASSOCIATED WITH INSTALLING, REMOVING OR REINSTALLATION OF THE PRODUCT.**
- b) Damage caused by Product malfunction or failure attributable to acts of God.
- c) Improper use or installation.
- d) Poor or no maintenance.
- e) Work performed by someone other than an Authorized Stanley technician.
- f) Failure to follow Stanley's operating instructions or environmental specifications.
- g) Incorrect application, modification, vandalism, erosion or corrosion, shipping and/or handling, improper storage, accident, misuse, abuse or any other cause not within the control of Stanley.
- h) This warranty is void if any modification is made to the warranty product, regardless of whether the modification causes or contributes to the alleged defect. All modifications are made at the risk and expense of the party making the modifications.
- i) Stanley shall not be liable for any repairs, replacements, or adjustments to the product or any costs of labor performed by the Purchaser or others without Stanley's prior written approval.
- j) Stanley provides no warranty or guarantee that its cores and/or cylinders will function properly or be mechanically compatible with products not manufactured by Stanley.
- k) The US10B/613 finish is considered to be a living finish that will change over time with use and age and is expressly excluded from this warranty. The finish changes that occur are indicative of normal wear and tear and reflect the essence of a living finish. The finish changes are not considered manufacturing defects and are not covered by this warranty.

Third Party Warranty: Except as otherwise provided above, Stanley makes no warranty, express or implied, with regard to third party hardware or software and expressly disclaims the implied warranties or conditions of merchantability or merchantable quality, fitness for a particular purpose, title, infringement and those arising by statute or otherwise in law. Customer's sole recourse for warranty claims is with the manufacturer of the Product. However, Stanley agrees to pass through any third party warranty that Stanley receives from the manufacturer of the Products to Purchaser. The extent of any third party warranty details, terms and conditions, remedies and procedures may be expressly stated on, or packaged with, or otherwise accompanying the Products.

LIMITATION OF WARRANTIES: THIS WARRANTY IS GIVEN EXPRESSLY AND IN PLACE OF ALL OTHER WARRANTIES, EXPRESS OR IMPLIED, INCLUDING ANY IMPLIED WARRANTIES OF MERCHANTABILITY OR FITNESS FOR PARTICULAR PURPOSE. THERE ARE NO UNDERSTANDINGS, AGREEMENTS, REPRESENTATIONS, OR WARRANTIES NOT SPECIFIED HEREIN.

STANLEY SHALL NOT, IN ANY EVENT, BE LIABLE FOR ANY CONSEQUENTIAL, INCIDENTAL, INDIRECT, SPECIAL OR PUNITIVE DAMAGES SUFFERED BY PURCHASER OR ANYONE CLAIMING BY, THROUGH OR UNDER PURCHASER, AS A RESULT OF THE CONDITION OF THIS PRODUCT, OR ANY PART OR PORTION THEREOF.

SOME STATES DO NOT ALLOW LIMITATIONS ON HOW LONG AN IMPLIED WARRANTY LASTS OR PROHIBIT THE EXCLUSION OR LIMITATION OF INCIDENTAL OR CONSEQUENTIAL DAMAGES, SO THE ABOVE LIMITATION AND EXCLUSIONS MAY NOT APPLY IN YOUR STATE.

THIS WARRANTY IS GOVERNED BY THE LAW OF THE STATE OF INDIANA WITHOUT REGARD TO ITS CONFLICTS OF LAW PRINCIPLES. STANLEY AND PURCHASER AGREE THAT THE UNITED NATIONS CONVENTION ON CONTRACTS FOR THE INTERNATIONAL SALE OF GOODS SHALL NOT APPLY TO SALE OF THE PRODUCTS COVERED BY THIS WARRANTY.

STANLEY®

General Information

Handing

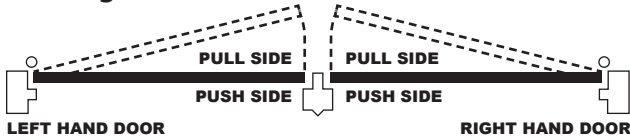

Closing Power Adjustment

Closers with spring power adjustment to size (6) are set at size (3) before leaving the factory. Closers with spring power adjustment from 1-4 or 1-5 are set at size (2) before leaving the factory.

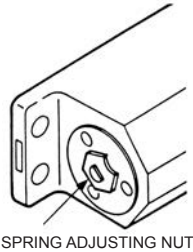

SPRING ADJUSTING NUT

Interchangeable Arms

All D-3550/D-3551 and D-4550/D-4551 Series arms are interchangeable.

Thru Bolts and Sex Nuts

When thru bolting is ordered, factory will furnish sex nuts for use with the machine screws furnished with the closer. Nuts are sized to accommodate 1-3/4" thick doors.

D-4550, D3550 - 12/24 thread	\$2.00
D-1610 - 12/24 thread	\$2.00

Security Screws

All mounting screws will be Torx pin tamper resistant machine screws. Available for Heavy Duty Arm applications only. Specify SEC Security Screws.

Delayed Action

A delayed action feature is available with this series for all applications and arms. The feature permits the door to close very slowly through the delayed action cycle. To order, suffix DA to closer number.

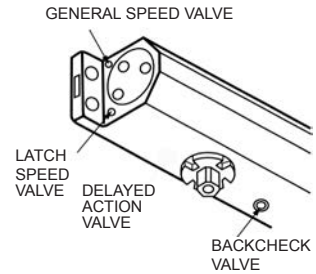

Advanced Variable Backcheck (AVB) optional Cylinder starts backcheck at approximately 45° instead of the normal 75°. Add suffix "AVB" to selected cylinder. When combined with Delayed Action consult factory for special template (Heavy Duty Arm applications).

Packing

All surface mounted closers with standard arm sets are packed for mounting on regular, parallel arm or top jamb applications. D-1610 Series are packaged (6) closers per case. D-4550/D-3550 are packaged (4) closers per case. D-4550EH are packaged individually.

ANSI and UL Specifications

The Stanley door closers D-1610, D-3550, D-4550 Series meet the requirements of the ANSI/BHMA Standard A156.4 – 2000 Grade 1. Underwriters' Laboratories and Underwriters' Laboratories of Canada Listing. "For Self-Closing Doors Without Hold-Open feature" on R7551®.



How To Order

CLOSERS

Options: add suffix

- AVB - Advanced Variable Backcheck (optional)
- DA - Delayed Action (optional)
- LL - Lead Lined Cover (optional)
- MC - Metal Cover (optional)

Size: 0 - (refer to individual closer)
1 - size 1-5

Model No.

Arm Type: add suffix

- L - Long Rod Forearm (TJ only)
- H - Standard Hold-Open
- HL - Standard Hold-Open w/ Long Rod & Shoe
- HXL - Standard Hold-Open w/ Long Rod & Shoe
- PH - Parallel Hold-Open
- EDA - Heavy Duty Arm
- EH - Electronic Hold-Open
- H-EDA - Heavy Duty Arm w/ Hold-Open
- S - Heavy Duty Arm w/ Stop
- CS - Heavy Duty Arm w/ Compression Stop
- HS - Heavy Duty Arm w/ Hold-Open & Stop
- HCS - Heavy Duty Arm w/ Hold-Open & Comp Stop
- T - Track Mount
- HT - Track Mount w/ Hold-Open
- TCS - Track Compression Stop

CLD-4550DAEDA × 689 × SN

Finish:

- 689 - Aluminum
- 690 - Statuary Bronze
- 691 - Bronze
- 693 - Black
- 695 - Dark Bronze
- 696 - Brass

Finish Option:

- SRI - Special Rust Inhibitor

Fasteners:

- * SN - Sex Nuts & Bolts
Wood & Machine
Screws Furnished Standard
- SEC - Security Screws

STANLEY®

Low Energy Operators
(Non-handed)



D-4990T



D-4990

Accessories

6" Round 6" Ring



4 1/2" Square



Jamb

Dual Plate



Touchless



433



Push Plate
Posts



D-4990 Low Energy Operators and Accessories

For additional switch plates available contact your local STANLEY Security representative.

DESCRIPTION	Product No.	List Price
8R-D-4990 Series - Push Side Mount (includes arm assembly)	D-4990	3,900
8R-D-4990T Series - Pull Side Mount (includes arm assembly)	D-4990T	4,068
Arm Assemblies		
Used with D-4990 only	A45-501L	95
Used with D-4990T only	A45-507T	159
Optional Power Supply 24VDC @ 0.5A	PS-490	59
6" Round Stainless Steel Plate		
Handicap logo and Push-to-Open text	CL2216	220
6" round surface mount box	CL2220	94
6" round weather ring	CL2223	18
4 3/4" Square Stainless Steel Plate		
Handicap logo and Push-to-Open text	CL2102	206
4-3/4" square surface mount box	CL2236	94
4 1/2" Square Stainless Steel Plate		
Handicap logo and Push-to-Open text	CL4163	206
4 1/2" square surface mount box	CL4638	94
Jamb Stainless Steel Plate		
Handicap logo and Push-to-Open text	CL2055	162
Surface mount box	CL2245	28
Dual Push Plate "Vestibule Plate"		
Vestibule plate with text, logo and arrows	CL2388	319
Touchless Push Plates		
Touchless push plate fits single/double gang box	CL2025	331
Radio Control 433 Transmitters / 433 Receiver		
Digital transmitter 433MHz w/flag conn 9v battery (1 button)	CL4490	215
433 MHz digital receiver	CL4485	237
Push Plate Posts		
Silver - mounting post for stainless steel push plates*	CL2248	444
Black - mounting post for stainless steel push plates*	CL2247	429
Bronze - mounting post for stainless steel push plates*	CL2249	444
*For use with 4 1/2" square plates part # CL4163		
Push Plate Packages		
Includes (2) CL4163 Text & Logo plates, (2) CL4638 boxes, (2) CL4490 (9volt) Transmitters, (1) CL4485 Receiver	CL4976	1,256
Includes (2) CL4163 Text & Logo plates, (2) CL4638 boxes, HARD WIRED SOLUTION ONLY	CL4977	592
Includes (2) CL2102 Text & Logo plates, (2) CL2236 boxes, (2) CL4490 (9 volt) Transmitters, (1) CL4485 Receiver	CL4980	1,254
Includes (2) CL2102 Text & Logo plates, (2) CL2236 boxes, HARD WIRED SOLUTION ONLY	CL4981	592
Includes (2) CL2216 Text & Logo Plates, (2) CL220 boxes, (2) CL4490 (9 volt) Transmitters, (1) CL4485 Receiver	CL4990	1,282
Includes (2) CL2216 Text & Logo Plates, (2) CL220 boxes, HARD WIRED SOLUTION ONLY	CL4991	438
LOW ENERGY OPERATOR		Weight
D-4990 / D-4990T		40 lbs.

To Order: Specify: 8R-D-4990 x 628. Accessories ordered separate.

STANLEY®

D-4550 / D-4551 Series Surface Closers

COMPLETE CLOSERS

APPLICATION	D-4550 / D-4551 Series	Weight	List Price
Standard, Parallel Arm, Top Jamb	Std. w/PA Brkt	9 lbs	424
Long Rod Forearm (Top Jamb Only)	L	9 lbs	424
Hold Open Arm (Standard & Top Jamb)	H	9 lbs	455
Hold Open Parallel Arm	PH	9 lbs	455
Heavy Duty Arm (PA Only)	EDA	11 lbs	455
Electronic Hold Open	EH	11 lbs	785
Heavy Duty Arm w/ Hold Open (PA Only)	H-EDA	11 lbs	506
Heavy Duty Arm w/ Stop (PA Only)	S	11 lbs	497
Heavy Duty Arm w/ Compression Stop (PA Only)	CS	11 lbs	663
Heavy Duty Arm w/ Hold Open & Stop (PA Only)	HS	11 lbs	550
Heavy Duty Arm w/ Hold Open & Compression Stop (PA Only)	HCS	11 lbs	705
Track Mounting (Pull Side Only)	T	10 lbs	488
Track Mounting with Hold Open (Pull Side Only)	HT	10 lbs	506
Track Compression Stop	TCS	10 lbs	506

OPTIONS

Advanced Variable Back check Option	AVB	18
Delayed Action Cylinder Option	DA	36
Sex Nuts (add 1 package per closer - 4 sex nuts per pkg.)	SN	8
Lead Lined Cover	LL	72
Metal Cover (brushed, stainless steel standard)	MC	52
Security Screws	SEC	73
Special Rust Inhibitor	SRI	38

CYLINDER ASSEMBLY SETS

DESCRIPTION	Assembly No.	Weight	List Price
Cylinder Body and Cover, size 2-6	DB-4550	7 lbs	329
Cylinder Body and Cover, size 1-5	DB-4551	7 lbs	329
Cylinder Body and Cover with DA, size 2-6	DB-4550DA	7 lbs	365
Cylinder Body and Cover with DA, size 1-5	DB-4551DA	7 lbs	365

ARM ASSEMBLY SETS

DESCRIPTION	Assembly No.	Weight	List Price
Standard Arm Set (Std, PA & Top Jamb)	A45-501	2 lbs	95
Standard Arm with Long Rod and Shoe Set (Top Jamb)	A45-501L	2 lbs	95
Standard Hold-Open Arm Set (Std & Top Jamb)	A45-501H	2 lbs	126
Standard Hold-Open Arm w/ Long Rod and Shoe Set	A45-501HL	2 lbs	126
Standard Hold-Open Arm w/ Long Rod and Shoe Set	A45-501HXL	2 lbs	126
Parallel Hold-Open Arm Set	A45-503H	2 lbs	126
Heavy Duty Parallel Arm Set	A45-505	4 lbs	126
Heavy Duty Parallel Arm Set w/ Hold-Open	A45-505H	4 lbs	177
Heavy Duty Parallel Arm Set w/ Stop	A45-505S	4 lbs	168
Heavy Duty Parallel Arm Set w/ Compression Stop	A45-505CS	4 lbs	334
Heavy Duty Parallel Arm Set w/ Hold-Open and Stop	A45-505HS	4 lbs	221
Heavy Duty Parallel Arm Set w/ Hold-Open and Comp Stop	A45-505HCS	4 lbs	376
Track Rail Arm and Track Set (Pull Side Only)	A45-507T	3 lbs	159
Track Rail Arm and Hold-Open Track Set (Pull Side Only)	A45-507HT	3 lbs	177
Track Compression Stop	A45-507TCS	3 lbs	177
Electronic Hold-Open Track Arm Assembly	A45-507EH	3 lbs	456

NOTES

- Closers available in the following painted finishes: Aluminum (689) Dark Bronze (695) Statuary Bronze (690) Bronze (691) Brass (696) Black (693).
- Arm Assemblies are interchangeable between D-4550 and D-3550 Series Closers.

STANLEY®

D-3550 / D-3551 Series Surface Closers

COMPLETE CLOSERS

APPLICATION	D-3550 / D-3551 Series	Weight	List Price
Standard, Parallel Arm, Top Jamb	STD w/PA Brkt	7 lbs	346
Long Rod Forearm (Top Jamb Only)	L	7 lbs	346
Hold Open Arm (Standard & Top Jamb)	H	7 lbs	377
Hold Open Parallel Arm	PH	7 lbs	377
Heavy Duty Arm (PA Only)	EDA	9 lbs	377
Heavy Duty Arm w/ Hold Open (PA Only)	H-EDA	9 lbs	428
Heavy Duty Arm w/ Stop (PA Only)	S	9 lbs	419
Heavy Duty Arm w/ Compression Stop (PA Only)	CS	9 lbs	585
Heavy Duty Arm w/ Hold Open & Stop (PA Only)	HS	9 lbs	472
Heavy Duty Arm w/ Hold Open & Compression Stop (PA Only)	HCS	9 lbs	627
Track Mounting (Pull Side Only)	T	8 lbs	410
Track Mounting w/ Hold Open (Pull Side Only)	HT	8 lbs	428
Track Compression Stop	TCS	8 lbs	428

OPTIONS

Delayed Action Cylinder Option	DA	36
Sex Nuts (add 1 package per closer - 4 sex nuts per pkg) SN 6	SN	8
Security Screws	SEC	73
Special Rust Inhibitor	SRI	38

CYLINDER ASSEMBLY SETS

DESCRIPTION	Assembly No.	Weight	List Price
Cylinder Body and Cover, size 2-6	DB-3550	5 lbs	251
Cylinder Body and Cover, size 1-4	DB-3551	5 lbs	251
Cylinder Body and Cover with DA, size 2-6	DB-3550DA	5 lbs	287
Cylinder Body and Cover with DA, size 1-4	DB-3551DA	5 lbs	287

ARM ASSEMBLY SETS

DESCRIPTION	Assembly No.	Weight	List Price
Standard Arm Set (Std, PA & Top Jamb)	A45-501	2 lbs	95
Standard Arm with Long Rod and Shoe Set (Top Jamb)	A45-501L	2 lbs	95
Standard Hold-Open Arm Set (Std & Top Jamb)	A45-501H	2 lbs	126
Standard Hold-Open Arm w/ Long Rod and Shoe Set	A45-501HL	2 lbs	126
Standard Hold-Open Arm w/ Long Rod and Shoe Set	A45-501HXL	2 lbs	126
Parallel Hold-Open Arm Set	A45-503H	2 lbs	126
Heavy Duty Parallel Arm Set	A45-505	4 lbs	126
Heavy Duty Parallel Arm Set w/ Hold-Open	A45-505H	4 lbs	177
Heavy Duty Parallel Arm Set w/ Stop	A45-505S	4 lbs	168
Heavy Duty Parallel Arm Set w/ Compression Stop	A45-505CS	4 lbs	334
Heavy Duty Parallel Arm Set w/ Hold-Open and Stop	A45-505HS	4 lbs	221
Heavy Duty Parallel Arm Set w/ Hold-Open and Comp Stop	A45-505HCS	4 lbs	376
Track Rail Arm and Track Set (Pull Side Only)	A45-507T	3 lbs	159
Track Rail Arm and Hold-Open Track Set (Pull Side Only)	A45-507HT	3 lbs	177
Track Compression Stop	A45-507TCS	3 lbs	177

COVERS

4550/3550 SERIES	Part No.	List Price
4550 Series Cover	C-455	17
4550 Series Metal Cover (brushed, stainless steel standard)	MC-455	55
3550 Series Cover	C-355	17

STANLEY®

D-3550 / D-3551 Series Surface Closers (continued)

NOTES

- Closers available in the following painted finishes: Aluminum (689) Dark Bronze (695) Statuary Bronze (690) Bronze (691) Brass (696) Black (693).
- Arm Assemblies are interchangeable between D-4550 and D-3550 Series Closers.

D-1610 / D-1611 Series Surface Closers

COMPLETE CLOSERS - (LESS COVER)

APPLICATION	D-1610 / D-1611 Series	Weight	List Price
Standard, Parallel Arm, Top Jamb	Std w/PA Brkt	5 lbs	178
Long Rod Forearm (Top Jamb Only)	L	5 lbs	178
Hold Open Arm (Standard & Top Jamb Only)	H	5 lbs	215
Hold Open Parallel Arm	PH	5 lbs	215

OPTIONS

Full Cover	FC	1 lb	14
Sex Nuts (add 1 package per closer - 4 sex nuts per pkg)	SN		8
Security Screws	SEC		73
Special Rust Inhibitor	SRI		38

CYLINDER ASSEMBLY SETS

DESCRIPTION	Assembly No.	Weight	List Price
Cylinder Body and Cover, size 2-5	DB-1610	4 lbs	134
Cylinder Body and Cover, size 1-4	DB-1611	4 lbs	134

ARM ASSEMBLY SETS

DESCRIPTION	Assembly No.	Weight	List Price
Standard Arm Set (Std, PA & Top Jamb)	A16-401	1 lb	44
Standard Arm with Long Rod (Top Jamb)	A16-401L	1 lb	44
Standard Hold-Open Arm Set (Std & Top Jamb)	A16-401H	1 lb	81
Hold Open Parallel Arm	A16-403H	1 lb	81

FULL COVER SETS

DESCRIPTION	Assembly No.	Weight	List Price
Full Cover	C-165	1 lb	14

NOTES

- Closers are shipped standard Less Cover.
- Closers available in the following painted finishes: Aluminum (689) Dark Bronze (695) Statuary Bronze (690) Bronze (691) Brass (696) Black (693).
- Closers are packed (10) per case.

STANLEY®

CO-30/CO-50 Series Concealed Closers

CONCEALED IN-DOOR CLOSERS

APPLICATION	CO-50 Series	Weight	List Price
Concealed In-Door Size 3	CO-53	5 lbs	355
Concealed In-Door Size 4	CO-54	5 lbs	355
Concealed In-Door Size 3 with Hold Open	CO-153	5 lbs	374
Concealed In-Door Size 4 with Hold Open	CO-154	5 lbs	374

OVERHEAD CONCEALED CLOSERS (HANDED)

APPLICATION	CO-50 Series	Weight	List Price
Overhead Concealed Size 5	CO-55	12 lbs	681
Overhead Concealed Size 6	CO-56	12 lbs	681
Overhead Concealed Size 5 with Hold Open	CO-155	12 lbs	693
Overhead Concealed Size 6 with Hold Open	CO-156	12 lbs	693

DOUBLE ACTING OVERHEAD CONCEALED CLOSERS (SIDE LOADING)

APPLICATION		Door Opening		30 Series	Weight	List Price
Max Opening	Hold Open	Max Int.	Max Ext.			
105°		3'-0"	2'-6"	30-21S	10 lbs	429
90°		3'-0"	2'-6"	30-23S	10 lbs	429
105°	105°	3'-6"	3'-0"	30-30S	10 lbs	429
90°		3'-6"	3'-0"	30-31S	10 lbs	429
105°	90°	3'-6"	3'-0"	30-32S	10 lbs	429
105°				30-34S	10 lbs	429
105°				30-41S	10 lbs	439

NOTES

- Closers available in the following painted finishes: Aluminum (689)

Mounting Accessories

D-4550 / D-4551 CYLINDER MOUNTING PLATES

DESCRIPTION	Part No.	Weight	List Price
Drop Plate (Std, PA or TJ Mount)	P45-180	4 lbs	57
Drop Plate (PA Mount) Heavy Duty for use with a narrow top rail	P45-180D	4 lbs	57
Angle Bracket (Push Side Mount)	P45-190	5 lbs	57
Adapter Plate for D4550 with Heavy Duty Arm Application to retrofit to LCN 4111 with Heavy Duty Arm Application	P45-4110	4 lbs	57
Adapter Plate for D4550 with Heavy Duty Arm Application to retrofit to LCN 4040 with Heavy Duty Arm Application	P45-4040	4 lbs	57

D-3550 / D-3551 CYLINDER MOUNTING PLATES

DESCRIPTION	Part No.	Weight	List Price
Drop Plate (Std, PA or TJ Mount)	P35-180	3 lbs	57
Angle Bracket (Push Side Mount)	P35-190	4 lbs	57

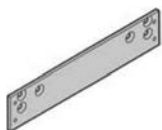
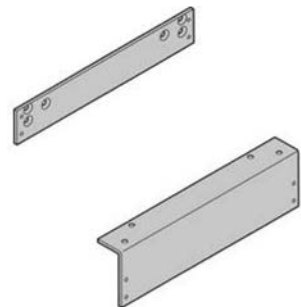
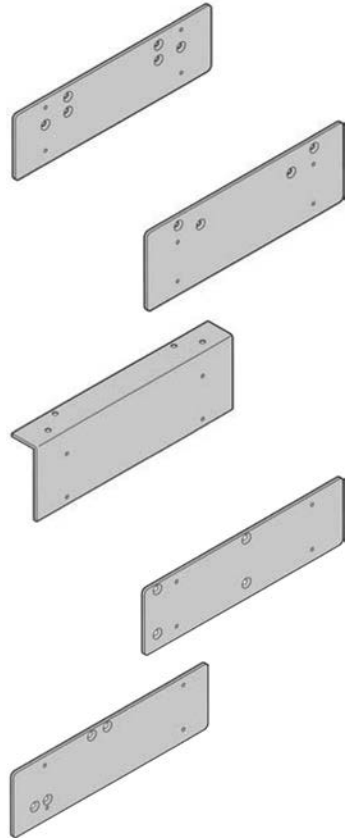

D-1650 / D-1651 CYLINDER MOUNTING PLATES

DESCRIPTION	Part No.	Weight	List Price
Drop Plate (Std, PA or TJ Mount)	P16-180	2 lbs	57



STANLEY®

D-4550 / D-3550 ARM MOUNTING ACCESSORIES

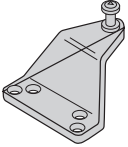
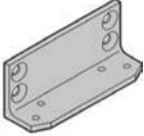
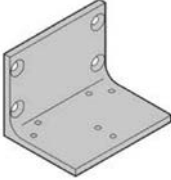
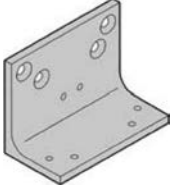
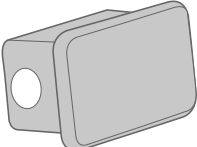
DESCRIPTION	Part No.	Weight	List Price
 Spacer Block for mounting PA Bracket on Rabbet	P45-110	1 lb	24
 Spacer Block for mounting HD Arms on Rabbet	P45HD-110	1 lb	25
 Angle Bracket for Shoe Support on HD Arms	P45HD-112	0.5 lbs	25
 Extra-Clearance Offset Soffit Plate Bracket	P45-113	1 lb	37
 Angle Bracket for mounting PA Bracket on Flush Transom	P45-114	1 lb	28
 Angle Bracket for mounting HD Arms on Flush Transom	P45HD-114	2 lbs	38
 Angle Bracket for mounting HD Arms on Flush Transom with Over Head Stop Applications	P45HD-114-1	2 lbs	38
 Track Arm End Cap Used on D-4550T/D-3550T with A45-507T	P45-507EC	.5 lbs	7

QUOTING & ORDERING

Price quotations are based on one (1) shipment to one (1) location, and are valid as identified in the quote but in no case longer than one year from the date of the quote. All exceptions will be evaluated on an individual basis.

All quotation requests will be provided by the Stanley Representative where the project is located.

QUOTING PROCESS AND PROCEDURES: The following information is necessary to secure a price quotation from Stanley.

- Distributor Name
- Distributor Location
- Distributor Contact Name & Phone Number
- Distributor e-mail contact
- Project Name
- Project Location
- Bid Date
- Architects Name, Phone Number, and Architects Location
- Specification Writer Name, Phone Number and Location
- Competitive Influence / Specification
- List of materials to be quoted

Every attempt will be made by Stanley to provide the price quotation in a timely manner. Upon completion, you will receive a copy of the quotation which will also include a valid quotation number. Once the project is secured, a copy of the quotation must accompany your purchase order and be forwarded to Stanley Customer Service Department in Indianapolis for processing.

NON-STANDARD PRODUCT REQUEST: Please contact your Stanley Representative to complete a Non-Standard Product Request Form. All requests should be submitted to the following email address:

Email: product_request@sbdinc.com

Upon receipt of a special order request, Stanley will review the configuration and determine if Stanley is capable of making the special order product and will provide a response to the customer. If Stanley is able to make the special order product, Stanley will provide a specific sku/configuration to the customer for the special order product. This sku/configuration must be identified on all Purchase Orders. In addition, the Purchase Order must be marked as a "Special Order".

ORDERING: The following information is required for Stanley to successfully process any order:

- Itemized Purchase Order (PO)
- Stanley Approved Quote

Please send all orders to BAS-orderentry.us@dormakaba.com or by fax to 877-835-1030

NOTE: for detailed information on how to place an order for Stanley Best products as well as Stanley masterkey services please see the detailed section regarding "Stanley Best Ordering".

ADD ON ORDERS FOR QUOTED PROJECTS: To place an add-on order from a quoted project the Distributor must include the original quote, PO number and/or Stanley's original order number. Add-On orders will be accepted for a period one (1) year from the original order date.

Add-On orders received that are outside of the aforementioned period will be forwarded to the Stanley Representative for re-quote.

STOCKING ORDERS: All orders for stock replenishment should be marked as "Stock" and indicate a "Ship To" address that coincides with the stocking Distributor warehouse location.

INCOMPLETE ORDER PROCESS: All orders are screened upon receipt for complete information. If an order is received incomplete, Stanley Customer Service will make one (1) attempt to contact a Distributor directly for the missing requirements. If the information is not made available to Stanley at that time the order will be referred to the local Stanley Representative for resolution. All incomplete orders will be cancelled if not resolved after sixty (60) calendar days.

PRICE DISCREPANCY PROCESS: All entered orders are reviewed by Stanley Customer Service for accuracy and pricing consistency between the Distributor and Stanley. Any order determined by Stanley, in its sole and absolute discretion, to have a value greater than the Total Price shown on the Distributor purchase order will be held by Stanley for a Price Discrepancy. Stanley quotes are also reviewed to ensure that they are complete, approved, and match the PO. Due to pricing sensitivity, all price discrepancies must be resolved exclusively by your Stanley Representative.

ORDER CANCELLATION/CHANGES: All requests for Order Cancellations and Changes (Quantity, Shipping, Finish, Function, etc) should be sent directly to Stanley Customer Service. Requests via phone will be accepted, but must be accompanied by a written request. Factory Order Number, PO Number, Account Info, and Detailed Changes must be clearly indicated. Change requests can be submitted via the following methods:

Email: BAS-cshelp.us@dormakaba.com
Fax: 1-877-835-1030

All order cancellations or changes will be subject to a cancellation fee as defined in Stanley's Terms and Conditions of Sale.

PRODUCTION SCHEDULING AND "DO NOT SHIP BEFORE" REQUESTS: All orders are scheduled for production and shipping based on current production lead times and availability. Scheduling is completed only when an order is released from both credit and pricing review.

Exceptions to this policy are made only when the PO is clearly marked: "Do Not Ship Before" followed by the date. (Required Date, Expected Date, etc. do not apply) These orders will be scheduled to ship on or after the date listed.

Changes to "Do Not Ship Before" dates are required in writing and should be sent to: BAS-cshelp.us@dormakaba.com.

Be advised orders not clearly marked with a "Do Not Ship Before" designation will be payable within normal terms from the actual shipment date.

EXPEDITE REQUESTS:

- Expedite requests will be reviewed and accommodated by Stanley based on production lead times and availability.
- See the then current Stanley Quick Ship Program for details.

QUOTING & ORDERING (continued)

WHOLESALE PURCHASE: Distributors are also free to utilize Stanley's Authorized Wholesalers to purchase product. Stanley does not make any guarantee of availability or pricing for purchases from an Authorized Wholesaler and the discounts afforded to Distributor by Stanley shall not apply to purchases from an Authorized Wholesaler. The terms and conditions and price of product shall be mutually as agreed between Distributor and Wholesaler.

RETURNED AUTHORIZATION (RA)

RA REQUESTS: A Return Authorization Form must be utilized to return defective products still under warranty or products deemed repairable by Stanley. All products returned to Stanley must have a correct Return Authorization (RA) number applied to the outside of the shipping carton. All products must be returned within sixty (60) calendar days of RA issue date. This process can take up to seven (7) days after product is received at Stanley's factory. If a defective product presents a security risk, an advance replacement may be requested.

RA PROCESS: Requests for warranty related returns can be initiated by submitting an email to **BAS-rgacreditgrp.us@dormakaba.com**.

The RA Request Form must be completed entirely to process an RA. The following information will be needed:

- End User Name
- Account Number
- Contact Name
- Phone Number
- Purchaser Order Number
- Sales Order Number
- Item Number
- Item Quantity
- Description of the Problem

1. Upon review and approval of the submitted RA request, a claim number is logged and provided back to the requestor by a Stanley Team member.
2. Once a claim number is issued, this number should be noted on all references and communications regarding the applicable situation to ensure a claim is easily identified.
3. Defective product should be returned to the address below. The shipment must be marked with the approved RA claim number to ensure prompt processing and attention. All shipping charges prepaid by customer.
BEST Access Solutions, Inc.
Attn: Returns Department
6161 East 75th Street
Indianapolis, IN 46250
4. When material is received at Stanley's factory, Stanley will assess and determine the nature of the defect.
5. Defective goods are replaced upon Stanley's determination.
6. Credit for material and freight is issued only if deemed appropriate by Stanley. If approved, credit is initiated and a credit memo is mailed to the Distributor within fifteen (15) business days.

PURCHASE ORDERS:

A Purchase Order (PO) will be required if the Product is:

1. Defective and not under warranty, or
2. An advance replacement is required without verification of whether the product is defective and under warranty.

Please send Purchase Orders to the following:

- Preferred Method Email:
BAS-rgacreditgrp.us@dormakaba.com
- Fax: 1-877-835-1030

RETURNED AUTHORIZATION (RA) NON-WARRANTY

RA POLICY: A Return Authorization Form must be utilized to return products that are not defective and otherwise in a resalable condition. Only goods with an invoice date of less than one (1) year will be considered for a non-warranty related return. All materials returned to Stanley for any reason (other than warranty), must have a correct Return Authorization (RA) number applied to the outside of the shipping carton. A thirty percent (30%) re-stocking charge (of the purchase price) will be applied to the Distributor's account for orders returned, including orders that were placed by customer in error. Transportation charges of returned goods must be prepaid by the Distributor. All goods must be returned within sixty (60) calendar days of RA issue date. All goods must be returned in original packaging and be in resalable condition. Product not returned in saleable condition is subject to disposal by Stanley with no credit issued. Commercial Hardware items that are special made to order items will not be returned under any circumstances.

RA PROCESS: Requests for non-warranty related returns can be initiated by submitting an email to **BAS-rgacreditgrp.us@dormakaba.com**.

The RA Request Form must be completed entirely to process an RA. The following information will be needed:

- End User Name
- Account Number
- Contact Name
- Phone Number
- Purchaser Order Number
- Sales Order Number
- Item Number
- Item Quantity
- Description of the Problem

1. Upon review and approval of the submitted RA request, a claim number is logged and provided back to the requestor by a Stanley Team member:
2. Once a claim number is issued, this number should be noted on all references and communications concerning said RA.
3. Product should be returned to the address below. The shipment must be marked with the approved RA claim number to ensure prompt processing and attention. All shipping charges prepaid by customer.

BEST Access Solutions, Inc.
Attn: Returns Department
6161 East 75th Street
Indianapolis, IN 46250

4. The RA will be processed once material is received at Stanley's factory provided it is received in its original packaging and is in saleable condition.
5. Credit is issued to the Distributor account and a credit memo is mailed to the Distributor.

FULFILLMENT ISSUES

Any quality issues (missing parts, wrong parts, handling, finish, etc) should be submitted electronically to: BAS-rgacreditgrp.us@dormakaba.com or your Local Stanley Representative.

Please reference your original Purchase Order (PO) Number, Factory Order Number, Distributor Account, Contact Information (E-mail/Fax), and include a detailed description of the issue.

1) ITEMS MISSING FROM A SHIPMENT: If you have signed your shipment short, Stanley Customer Service will promptly issue a No Charge replacement order for the missing products.

If the shipment was not signed short but after review, Stanley Customer Service determines (based on shipping weights, packing lists, etc) that the order was indeed shipped short, a No Charge replacement will be issued.

If Stanley Customer Service cannot verify a shipping error, an advance replacement order will be entered, charged, and expedited to the Distributor. The quality issue will be forwarded to the Return Authorization Credit Group for resolution.

If it is determined that the item was omitted from the order due to a Stanley order entry error, a change order will be entered and expedited for the missing products.

Please see Stanley's price book for further detail.

2) WRONG ITEMS RECEIVED (parts, handling, function, finish, etc):

Advanced replacements will be issued for any wrong items received. **Such orders will be charged based on pricing/ discounts from the original order.** The issue will be forwarded to Stanley's Return Authorization Credit Group for resolution.

Any quality issue that is determined to be either a Stanley order entry and/or manufacturing error will have an advanced replacement order entered and will be expedited. An RA will be issued to return the incorrect products. No re-stock fee will apply for Stanley order entry and/or manufacturing errors.

STANLEY®

RETURN ORDER REQUEST

- Return for Replacement** **Return for Credit**

Date of Request: _____

Original Order: _____

Date of Request: _____

Original P.O.: _____

Invoice #: _____

Customer Name: _____

Account Number: _____

Address: _____

City: _____

State: _____

Contact Name: _____

Email: _____

Phone: _____

- Ship Replacement Material to Address Above**

NATURE OF PROBLEM

- Manufacturing Defect
 Warranty Evaluation
 Missing Parts
 Wrong Materials Received
 Wrong Materials Ordered
 Wrong Quantity
 Return Inventory
 Other: _____

Note: All returns shall be subject to Stanley's current Terms of Sale and Warranty as outlined in Stanley's price catalog.

- Ship Replacement Material to Address on Order**

DETAILED DESCRIPTION OF DEFECT OR REASON FOR RETURN

RETURN MATERIAL

Line Item #	Quantity	Product Nomenclature	Product Description

Please e-mail completed form to BAS-rgacreditgrp.us@dormakaba.com or Fax to 1-888-214-1918

STANLEY®

6161 East 75th Street
Indianapolis, IN 46250 USA

Phone 855-365-2407

stanleyhardwarefordoors.com

PL67DC • 01/18

© 2017 dormakaba Holding. All rights reserved.

© 2017 Stanley Black & Decker, Inc. STANLEY® and the STANLEY® Notched Rectangle logo are registered trademarks of Stanley Black & Decker Inc. or one of its affiliates, and are used under license

dormakaba 

dormakaba.com